

1. A plató lap behelyezése az oldalba

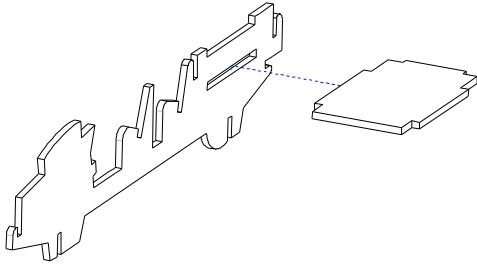

2. A másik oldallap felszerelése

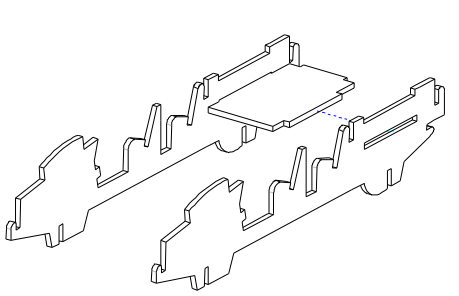

3. A taposólemez beillesztése

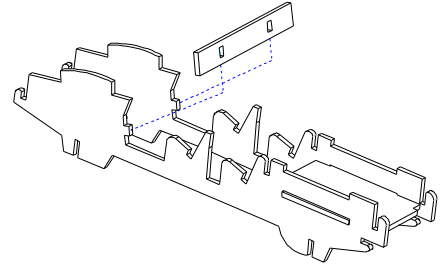
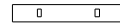

4. Az alváz és a kormányrúd szerelése

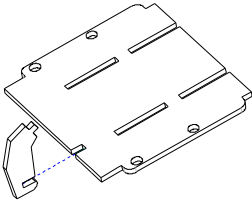
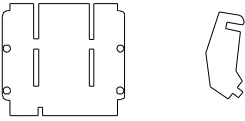

5. Majd behelyezése a vázba

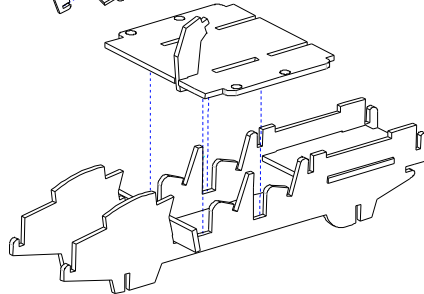
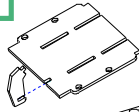

6. A hátsóülés háttámlája..

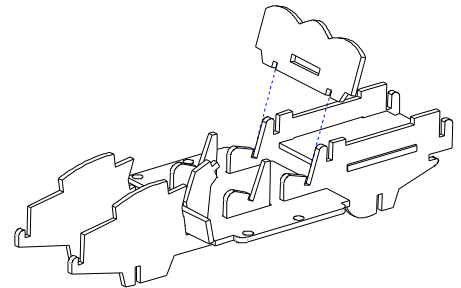

7. ...majd pedig az ülő rész szerelése

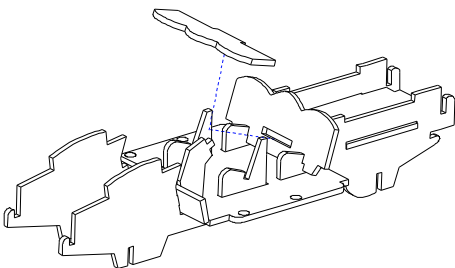

8. Az elsőülés háttámlája..

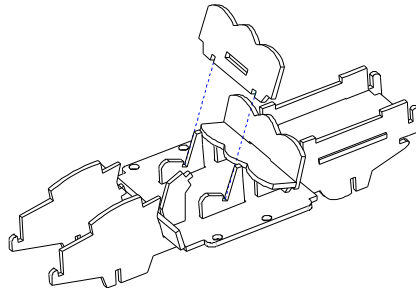
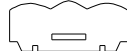

9. ...és az ülőke szerelése

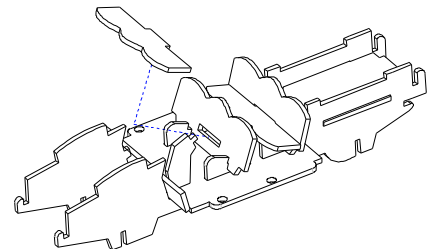
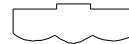

10. A kormány beillesztése

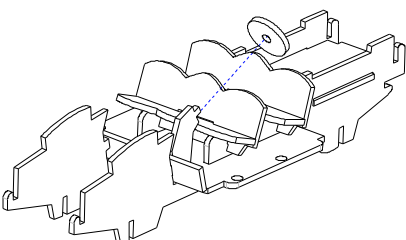

11. A motorháztető alap felszerelése

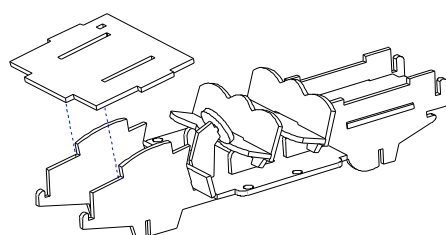
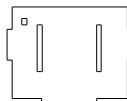

12. A bal külső oldallap szerelése

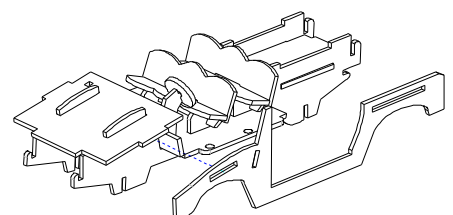
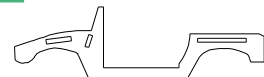

13. A szélvédő beillesztése

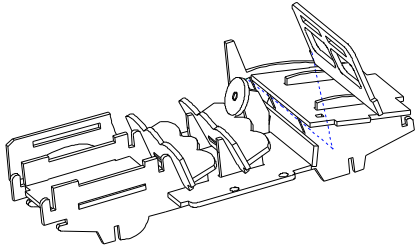
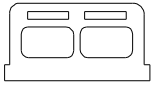

14. A jobb külső oldallap felszerelése

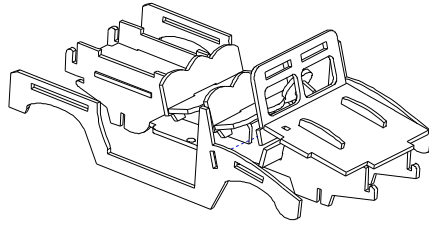
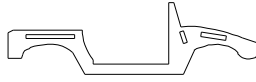

15. A homlokfal beillesztése

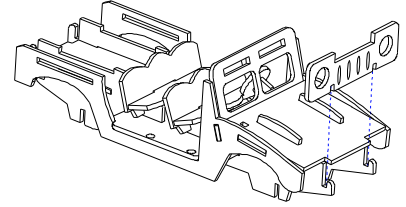
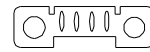

16. A motorháztető felső lap szerelése

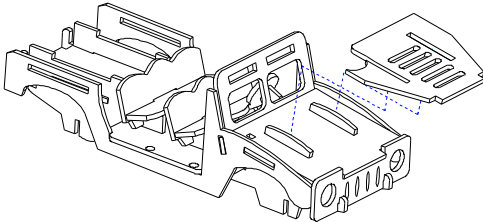

17. A plató-fellépő felszerelése

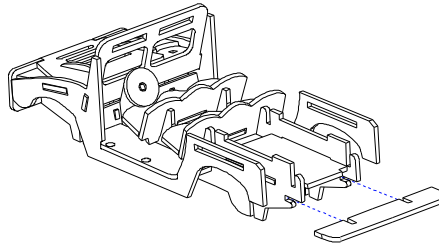

18. A kabin hátfala...

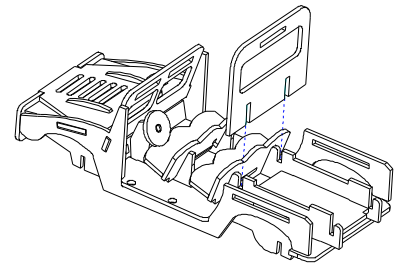
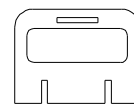

19. ...a plató padok...

2x 

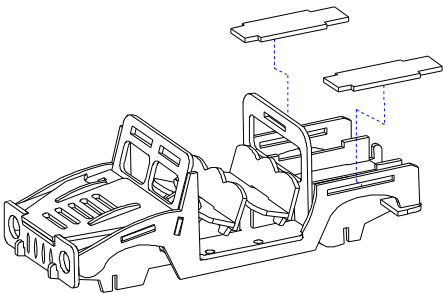

20. ...majd a plató hátfalának szerelése

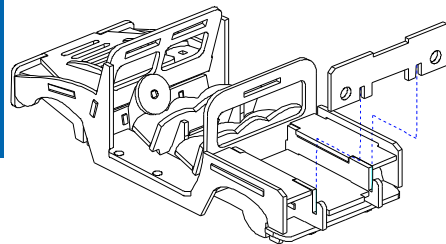
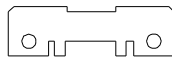

21. A jobb hátsó ajtó....

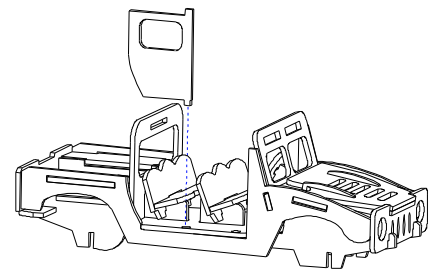

22. ...és a jobb első ajtó beillesztése.

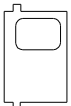

23. A jobb hátsó ajtó...

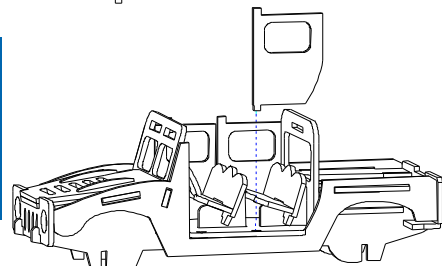

24. ...és a jobb első ajtó beillesztése

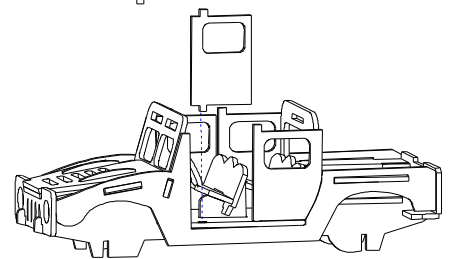
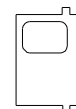

25. A kabintető felszerelése

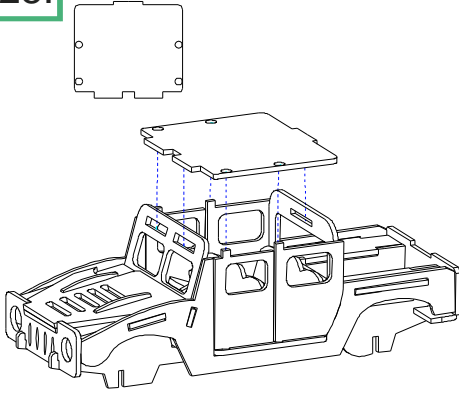

26. A légszűrő felszerelése

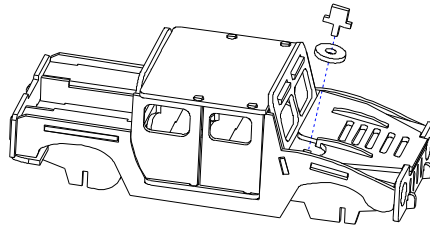

27. A kerek előszerelése (4x)

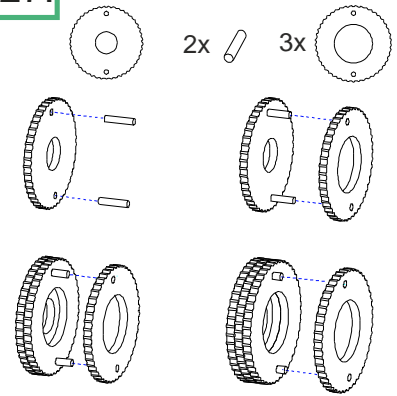

28. A tengelyek előszerelése (2X)

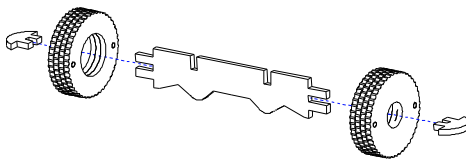
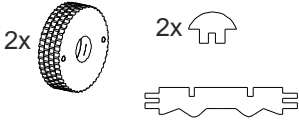

29. Az első tengely beszerelése

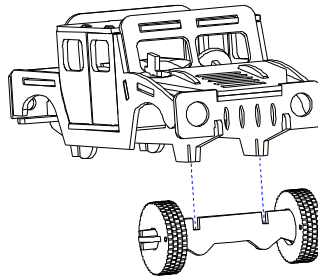

30. A hátsó tengely beszerelése

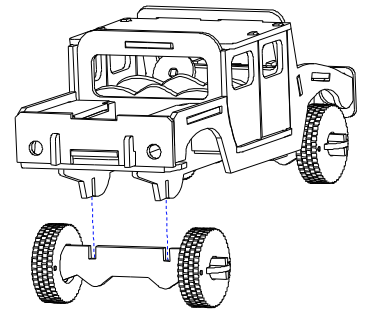

A kész modell

